

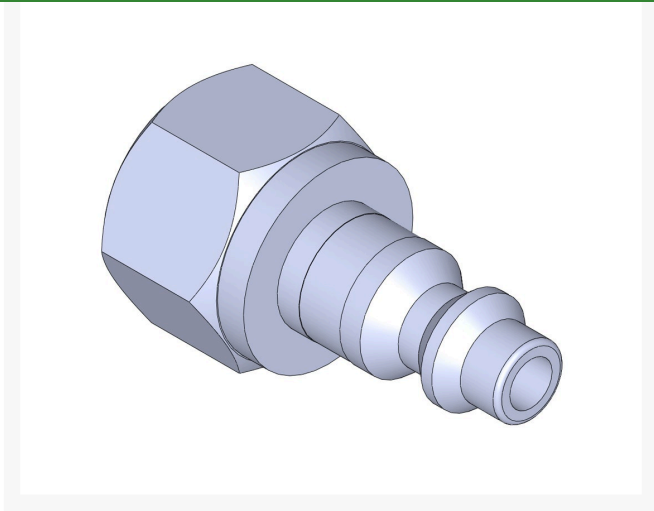

## Plug - Coupler 3/8 Nptf

R5562



### Details

Plated steel couplers with hardened steel balls & stainless steel springs or brass fittings that offer corrosion resistance, ductility at high temperatures, and low magnetic permeability. Maximum working pressure 300 PSI.

### Specifications

Manufacturer

R&R Products

**Baber Turf Equipment Co.**

Unit 6 / 10 Firth Street Auckland, 2113

09 294 6040

<https://baber.rrproducts.com/>