

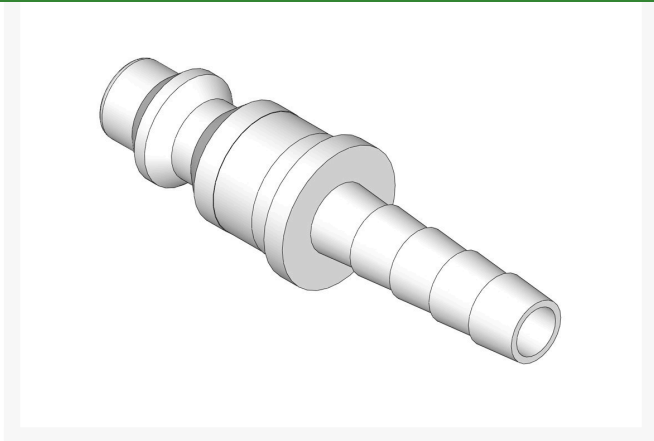

Plug - Coupler 1/4 Hose Barb

R5570



Details

Plated steel couplers with hardened steel balls & stainless steel springs or brass fittings that offer corrosion resistance, ductility at high temperatures, and low magnetic permeability. Maximum working pressure 300 PSI.

Specifications

Manufacturer

R&R Products

Baber Turf Equipment Co.

Unit 6 / 10 Firth Street Auckland, 2113

09 294 6040

<https://baber.rrproducts.com/>