



Replaces John Deere 3235B Reel Mower

Parts

Heavy Verti-Cut Unit

Verti-Cut Reel & Frame

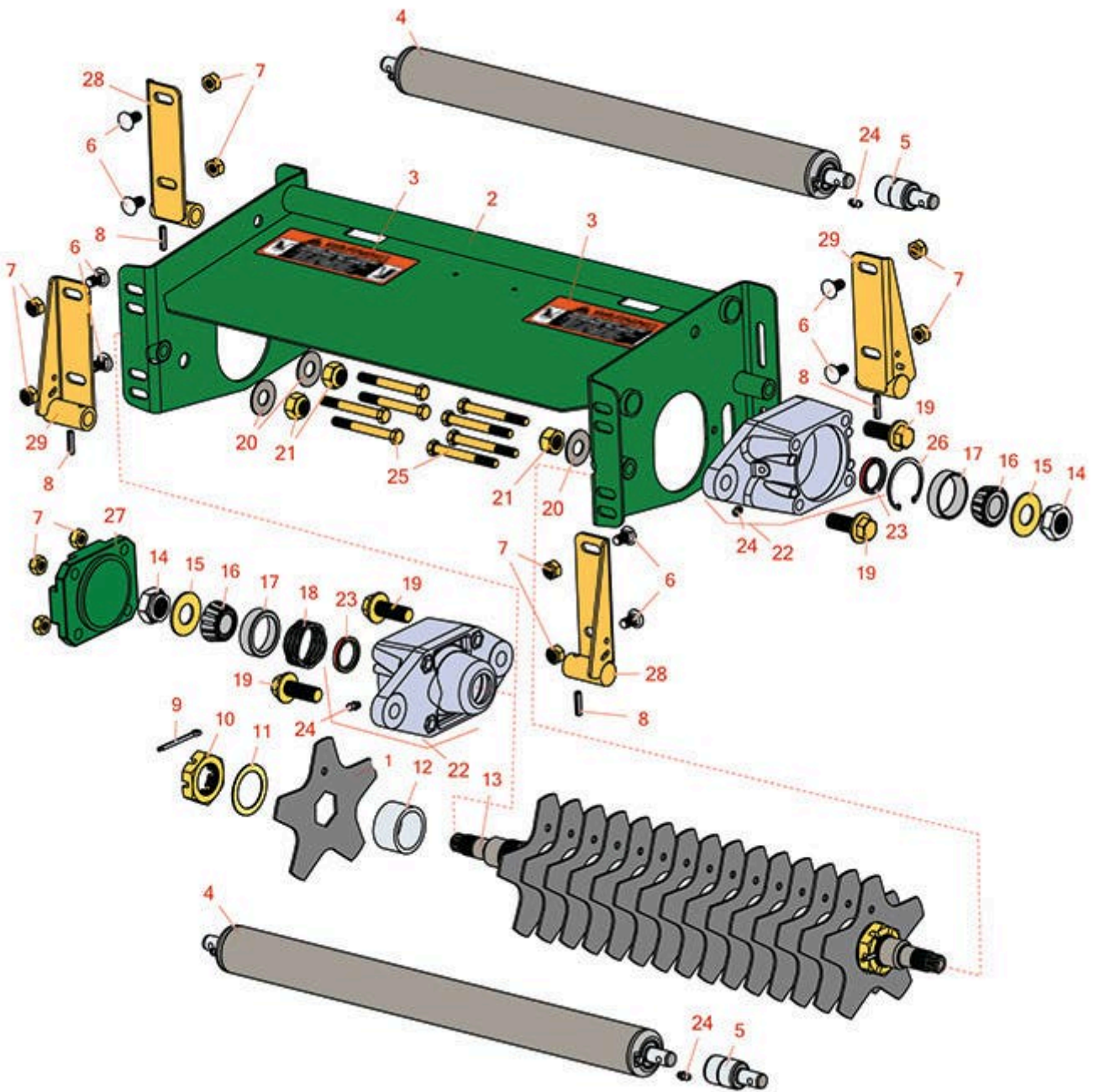

All original equipment manufacturers names and part numbers are used for identification purposes only, and we are in no way implying that our products are original equipment parts. Prices subject to change without notice.



Replaces John Deere 3235B Reel Mower Parts

Heavy Verti-Cut Unit
Verti-Cut Reel & Frame



Item No	R&R Part No.	OEM Part No.	Description	Qty Req	Order Quantity
Verti-Cut Blades					
1	RMT6987	MT6987	Verti-Cut Blade	16	
1	RMT6987C		Verti-Cut Blade - Carbide Tipped	16	
Other Parts Available					
2	RAMT479	AMT479	Frame - Verti-Cut	1	
3	RMT1520	MT1520	Label	2	
4	RAET10111	AET10111, AMT2876	Roller - Smooth Tubular Steel	2	
<i>Tech Note: This tubular steel roller uses greasable "water-pump" style bearings.:</i>					
5	RAA35741	AA35741, AET10129, TCA22836	Bearing	4	
<i>Tech Note: 1/4" Side Hole:</i>					
6	R03M7190	03M7190	Bolt - Carriage M10-1.5 x 20	8	
7	R14M7400	14M7400	Locknut - 10mm	8	
8	R34M7113	34M7113	Spring Pin - 6mm x 26mm	4	
9	R50-0	11M7032	Pin - Cotter 3/16 x 2	1	
10	RET17318	ET17318	Nut - Slotted Jam	1	
11	R24H1549	24H1549	Spacer	14	
12	RET17648	ET17648	Spacer	15	
13	RMT770	MT770	Shaft - Verti-Cut	1	
14	RMT1211	MT1211	Locknut - 7/8-14 All Metal	2	
15	RM81551	M81551	Washer - 1.840 OD	2	

All original equipment manufacturers names and part numbers are used for identification purposes only, and we are in no way implying that our products are original equipment parts. Prices subject to change without notice.



Replaces John Deere 3235B Reel Mower Parts

Heavy Verti-Cut Unit
Verti-Cut Reel & Frame



Item No	R&R Part No.	OEM Part No.	Description	Qty Req	Order Quantity
16	RJD8960	JD8960	Tapered Bearing Cone	2	
17	R254-90	JD8239	Tapered Bearing Cup	2	
18	RET17510	ET17510	Spring	1	
19	R19M7793	19M7793	Bolt - Hex HD Flanged M16	4	
20	RET16424	ET16424	Washer	4	
21	R14M7328	14M7328	Locknut - 16mm x 2.0 ESNA	4	
22	RAMT683	AMT683	Housing - Bearing w/Zerk and Seal	2	
23	RMT1115	MT1115	Seal - Reel	2	
24	R302-5	JD7797, JD7842, JD7844	Fitting - Grease	2	
25	R19M8197	19M8197	Bolt - Hx HD	8	
26	R32120-65	N51168	Ring - Retaining	1	
27	RET17645	MT7001	Cap - Reel Bearing Housing	1	
28	RAMT5050	AMT5050	Bracket - Roller - V-Cut Unit	2	

Tech Note: LH Front and RH Rear:

29	RAMT5051	AMT5051	Bracket - Roller - V-Cut Unit	2	
----	-----------------	---------	-------------------------------	---	--

Tech Note: RH Front and LH Rear:

All original equipment manufacturers names and part numbers are used for identification purposes only, and we are in no way implying that our products are original equipment parts. Prices subject to change without notice.