

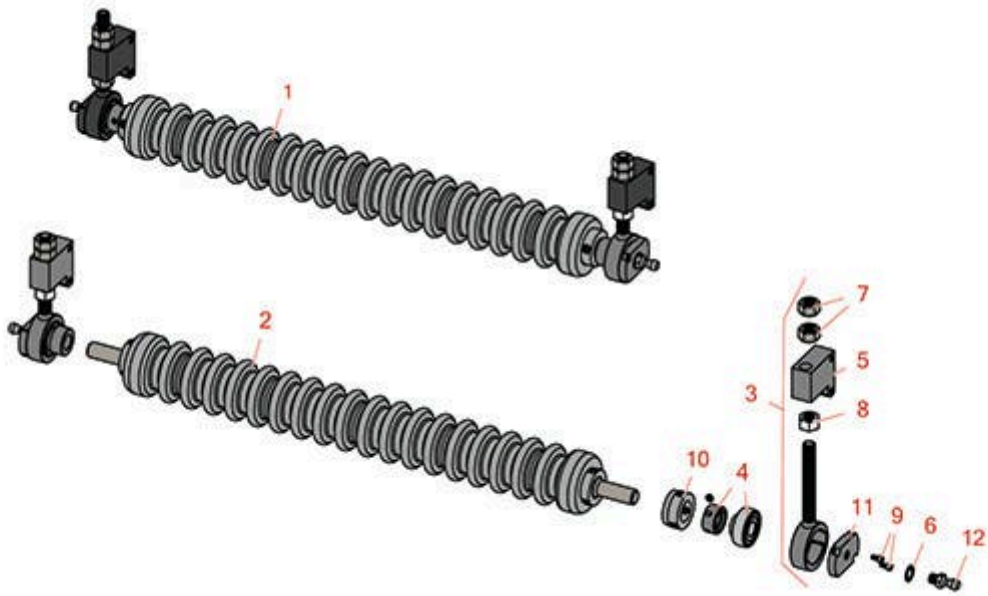

Replaces Toro Greensmaster 3000 Parts

SPA Cutting Unit - Models 04460, 04465 & 04478
Minuteman Roller System



All original equipment manufacturers names and part numbers are used for identification purposes only, and we are in no way implying that our products are original equipment parts. Prices subject to change without notice.



Replaces Toro Greensmaster 3000 Parts

SPA Cutting Unit - Models 04460, 04465 & 04478
Minuteman Roller System



Item No	R&R Part No.	OEM Part No.	Description	Qty Req	Order Quantity
---------	--------------	--------------	-------------	---------	----------------

Complete Minuteman Roller Systems

1	RMT8001		Minuteman Front Grooved Roller System	0	
---	----------------	--	---------------------------------------	---	--

Tech Note: Complete roller systems include roller and two brackets with bearings.:

Minuteman Rollers Only

2	RM513		Minuteman Grooved Roller Only	0	
---	--------------	--	-------------------------------	---	--

Tech Note: Use with Minuteman Roller Bracket System Only:

Other Parts Available

3	RT821		Bracket Assy - Front LH/RH	2	
---	--------------	--	----------------------------	---	--

Tech Note: Includes RT8210 Bearing & Locking Collar, RMM606 Washer, R3219-5 Nut & RMM607 Screw:

4	RMMB157		Bearing w/Locking Collar	2	
---	----------------	--	--------------------------	---	--

5	RT8210		Block - Height Adj	2	
---	---------------	--	--------------------	---	--

6	RMM606		Washer - Lock 3/8 Zinc Internal Tooth	2	
---	---------------	--	---------------------------------------	---	--

7	R3219-5	01-188-0820, 22-15-BJD, 22-15-BJKD, 3219-5	Nut - 1/2-20	4	
---	----------------	---	--------------	---	--

8	RMM607	01-158-0610, 01-191-0820, 21-3900, 3220-5, 45-0170, 5/1/3220	Nut - Jam 1/2-20 Zinc	2	
---	---------------	---	-----------------------	---	--

9	RMM608		Screw - 8-32 x 5/16 SS Socket Head	2	
---	---------------	--	------------------------------------	---	--

10	RMM3		End Hub - 7/8 ID	2	
----	-------------	--	------------------	---	--

11	RT821P		Plate - For RT821 Bracket	2	
----	---------------	--	---------------------------	---	--

12	RT821B		Ball - For RT821 Bracket	2	
----	---------------	--	--------------------------	---	--

All original equipment manufacturers names and part numbers are used for identification purposes only, and we are in no way implying that our products are original equipment parts. Prices subject to change without notice.



Replaces Toro Greensmaster 3000 Parts

*SPA Cutting Unit - Models 04460, 04465 & 04478
Minuteman Roller System*



All original equipment manufacturers names and part numbers are used for identification purposes only, and we are in no way implying that our products are original equipment parts. Prices subject to change without notice.