

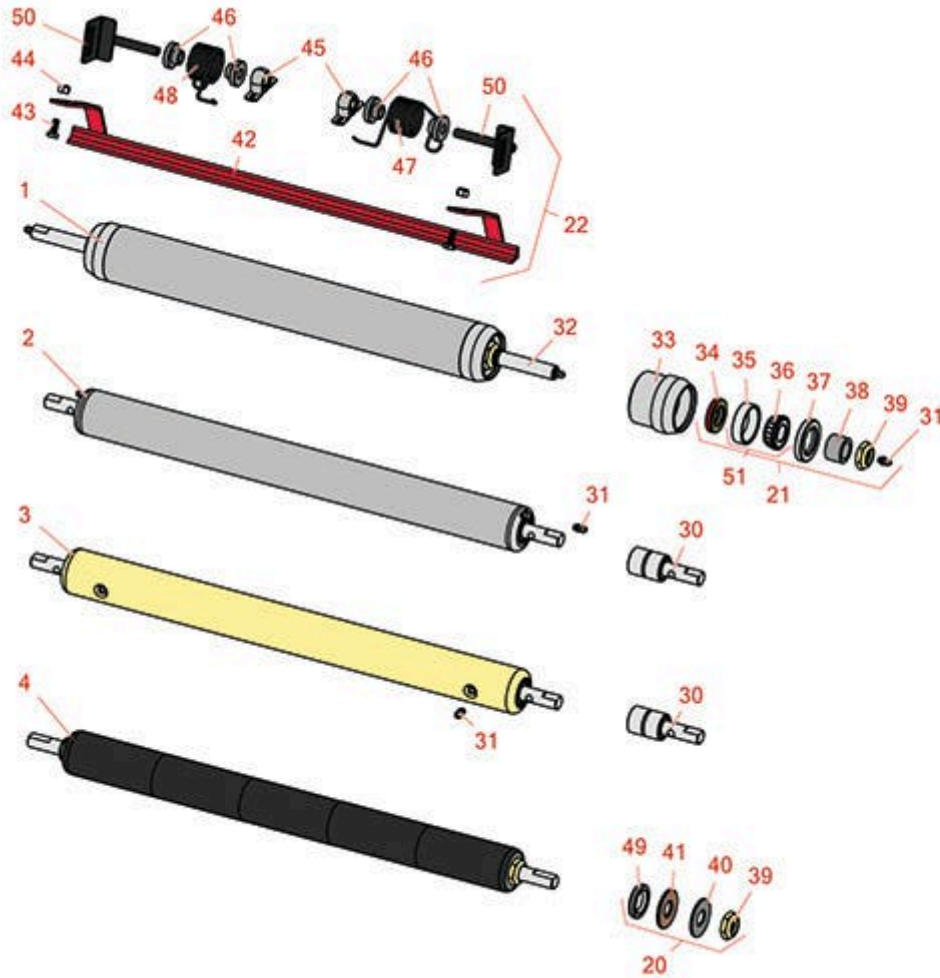

Replaces Toro Greensmaster 3050 Parts

SPA Cutting Unit - Models 04450 & 04468

Rear Rollers



All original equipment manufacturers names and part numbers are used for identification purposes only, and we are in no way implying that our products are original equipment parts. Prices subject to change without notice.



Replaces Toro Greensmaster 3050 Parts

SPA Cutting Unit - Models 04450 & 04468

Rear Rollers



Item No	R&R Part No.	OEM Part No.	Description	Qty Req	Order Quantity
---------	--------------	--------------	-------------	---------	----------------

R&R Rear Rollers

1	R150692	150692	Roller - Smooth Heavy Duty Tubular Steel	1	
---	----------------	--------	--	---	--

Tech Note: Constructed with a through shaft, this heavy duty roller uses tapered bearings for extended life.:

2	R21-8450	21-8450	Roller - Smooth Tubular Steel	1	
---	-----------------	---------	-------------------------------	---	--

Tech Note: Constructed with greasable "water-pump" style bearings. :

3	R150300	150300	Roller - Smooth Solid Steel	1	
---	----------------	--------	-----------------------------	---	--

Tech Note: Machined from solid steel, this heavy weight roller uses greasable "water-pump" style bearings.:

4	R150341	150341	Roller - Smooth UHMW Polyethylene	1	
---	----------------	--------	-----------------------------------	---	--

Tech Note: Machined from solid UHMW, this low maintenance roller uses a 1" solid stainless steel shaft and requires no grease. UHMW material prevents build-up of debris.:

Overhaul Kits

20	R101395		Overhaul Kit - UHMW Roller	1	
----	----------------	--	----------------------------	---	--

Tech Note: Fits all R&R 2" Dia. Black UHMW Polyethylene Rollers. Includes 10 ea.: R150322 Roll Pins; 2 ea.: R3296-15 Locknuts, R150347T Teflon Seals, R150333 Thrust Washers, & R150334A Bronze Thrust Washers:

21	R100136		Overhaul Kit - Roller	0	
----	----------------	--	-----------------------	---	--

Tech Note: Includes 2 ea.: R150674 Wear Sleeves, R253-152 Seals, R253-117 Seals, R254-78 Bearings, R254-79 Bearing Cups, R3296-15 Locknuts & R302-5 Grease Fittings:

22	R53-9240	42-4820, 53-9240	Scraper Kit - Rear Roller SET/3	1	
----	-----------------	---------------------	---------------------------------	---	--

Tech Note: Includes 12 ea: R19-9560 Spacer, R32152-4 Locknut, R400106 Bolt; 6 ea: R256-239 Bearing, R53-9250 Bracket; 3 ea: R19-9540 Spring, R19-9550 Spring, R42-4800 Scraper Bar:

Other Parts Available

All original equipment manufacturers names and part numbers are used for identification purposes only, and we are in no way implying that our products are original equipment parts. Prices subject to change without notice.



Replaces Toro Greensmaster 3050 Parts

SPA Cutting Unit - Models 04450 & 04468

Rear Rollers



Item No	R&R Part No.	OEM Part No.	Description	Qty Req	Order Quantity
30	R21-8430	21-8430	Bearing - Roller	2	
31	R302-5	21-6010, 302-11, 302-37, 302-47, 302-5, 302-57, 302-58, 302-6, 31-0300, 32-9660, 60-0800, 62-3880, 92-4181	Fitting - Grease	6	
32	R150693		Shaft - HD Rear Roller	1	
33	R61-0380	61-0380	Roller End - Cap Solid	2	
34	R253-152	253-116, 253-152	Seal - Inner Roller	2	
35	R254-79	01-103-0060, 01-103-0130, 1-633584, 252-106, 254-79, 32-7800, 32-9590	Cup - Bearing	2	
<i>Tech Note: Use R254-79M installation mandrel to properly install race.:</i>					
36	R254-78	01-102-0060, 01-102-0130, 1-633585, 254-78, 32-7790, 32-9580, 93-4813	Tapered Bearing Cone	2	
37	R253-117	253-117, 253-165	Seal - Outer Triple Lip	2	
38	R150674		Sleeve - Wear 3/4 Plated	2	

All original equipment manufacturers names and part numbers are used for identification purposes only, and we are in no way implying that our products are original equipment parts. Prices subject to change without notice.



Replaces Toro Greensmaster 3050 Parts

SPA Cutting Unit - Models 04450 & 04468

Rear Rollers



Item No	R&R Part No.	OEM Part No.	Description	Qty Req	Order Quantity
39	R3296-15	116-7306, 32118-5, 32127-23, 32127-47, 3296-15	Locknut - 3/4-16 Nylon Jam	2	
40	R150333		Washer - Flat Keyed Outer SS	2	
41	R150334A		Washer - Thrust SAE660 Bronze	2	
42	R42-4800	42-4800	Bar - Scraper Rear Roller	1	
43	R400106	321-3, 513315, 908002P	Bolt - Hex HD 1/4-20 x 5/8	4	
44	R32152-4	32152-4	Locknut - 1/4-20 All Metal	4	
45	R256-239	256-239	Bearing	2	
46	R19-9560	19-9560	Spacer - Spring	4	
47	R19-9540	19-9540	Spring - Torsion LH	1	
48	R19-9550	19-9550	Spring - Torsion RH	1	
49	R150347T		Seal - Nonstick Lip	2	
50	R53-9250	53-9250	Bracket - Scraper Mount	2	
51	R500534	1-633585	Bearing - with Cup	2	

All original equipment manufacturers names and part numbers are used for identification purposes only, and we are in no way implying that our products are original equipment parts. Prices subject to change without notice.